

Flush Cup Pocket Pulls (Dummy/Passage Only)

Specifications

Stainless Steel, Concealed Fixing, Screws included Only available for Dummy/Passage Functions
 Finishes: US32, US32D, US4, and (*where noted) US10B
 Ceramic Coating: Inquire about Lead Time

FHIX01*
Flush Cup Pull

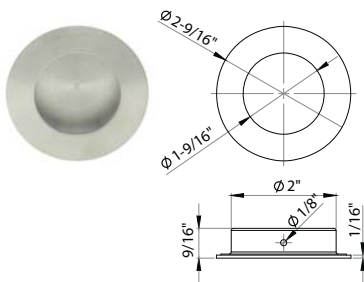

FHIX02
Flush Cup Pull

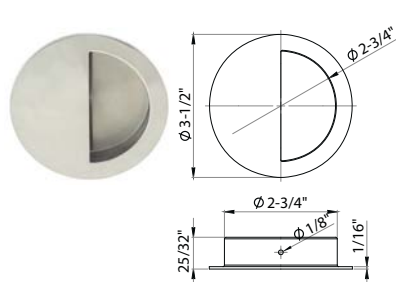

FHIX03
Flush Cup Pull

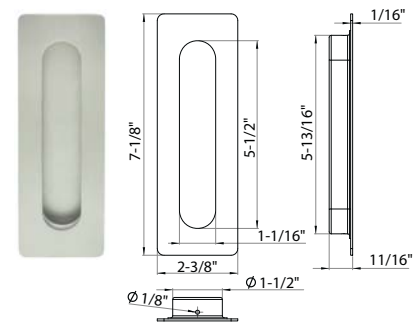

FHIX04
Flush Cup Pull

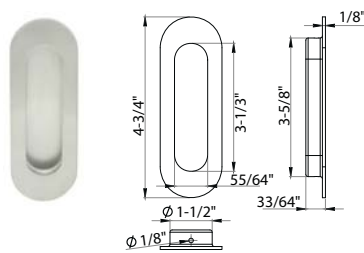

FHIX05*
Flush Cup Pull

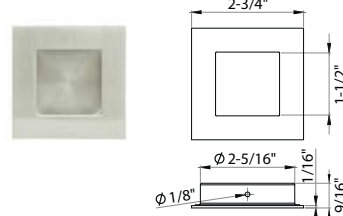

FHIX06*
Flush Cup Pull

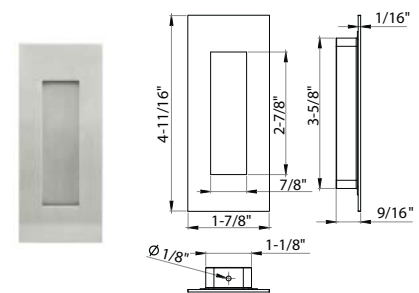

FHIX07
Flush Cup Pull

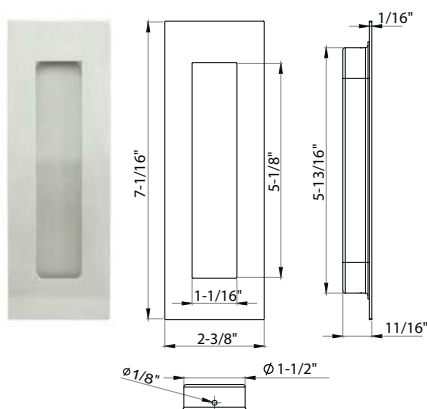

EPIX01*
Edge Pull

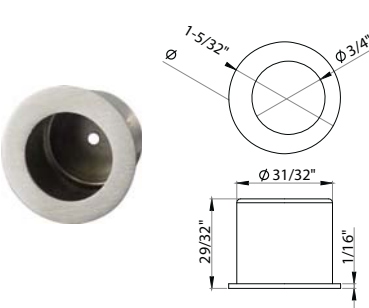

*Also available in Oil Rubbed Bronze (US10B/613)